

Dropsafe Accessories

Designed for use in harsh offshore and onshore environments, Dropsafe accessories provide application specific solutions to reduce dropped object risks.

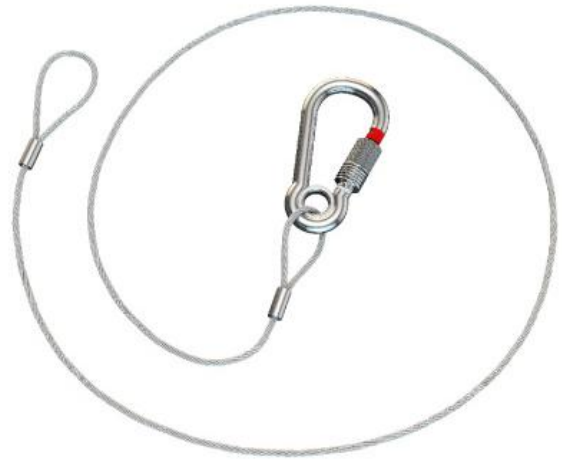

Application Types

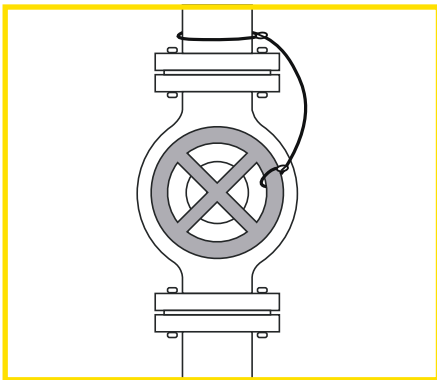

Valve Handle

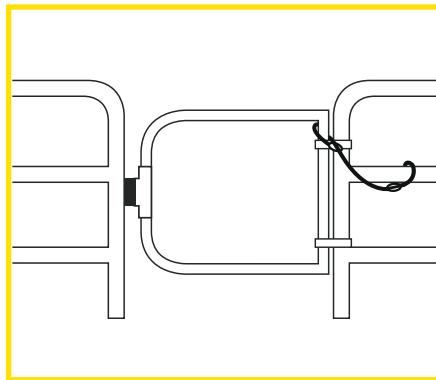

Swing Gate

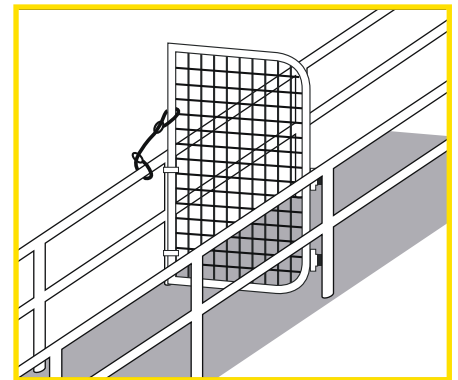

Access Gate

Quotations

It is important that you consider actual safety securing requirements and best practices when selecting Dropsafe Accessories. To order, complete the **“General RFQ Form”** (Photocopy from Product Guide or download from www.dropsafe.com/resource-centre) and email us at products@dropsafe.com.

IMPORTANT Dropped Object Prevention Best Practice

Use Dropsafe Nets as the best practice method of secondary retention (instead of wire or web slings). The Dropsafe 5X SWL, SUS316 nets fully enclose and tether the fixture and components, whereas slings do not fully retain the item being secured.

The light fixtures in these photos were retained using Dropsafe Nets, significantly reducing the risk of injury to personnel. This would not have been possible with a sling.



Crane boom light after collision



Light shade and impact guard dislodged due to corrosion

Features

316 SUS/AISI 316 stainless steel wire and components

5X SWL Designed and tested to over 5 times Safe Working Load (SWL)

Carabiner Carabiner with spring-loaded gate nut and safety indicator

Dropsafe Accessories - Products

Part No.: S014002141001



Lanyard + Carabiner
SWL: 1 kg (2.2 lbs)

A (Extended) =
1100 mm (43.3")
B = 70 mm (2.7")

Wire rope + Coating \varnothing =
3 mm
Carabiner \varnothing = 7 mm



Part No.: S028005152001



Carabiner
SWL: 80 kg (176 lbs)

A = 70 mm (2.7")
B = 35 mm (1.4")

Carabiner \varnothing = 7 mm

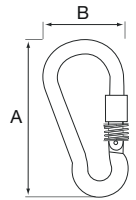

Part No.: S014002153001



Cable & Carabiner
SWL: 80 kg (176 lbs)

A = 1200 mm (47.2")
B = 70 mm (2.7")

Wire rope \varnothing = 3 mm
Carabiner \varnothing = 7 mm

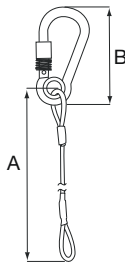

Part No.: S014002153101



Cable & Carabiner
SWL: 80 kg (176 lbs)

A = 2000 mm (78.7")
B = 70 mm (2.7")

Wire rope \varnothing = 3 mm
Carabiner \varnothing = 7 mm

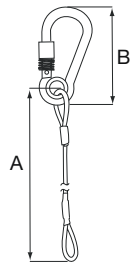

Part No.: S014001153301



Cable
SWL: 80 kg (176 lbs)

A = 1200 mm (47.2")
B = 70 mm (2.7")

Wire rope \varnothing = 3 mm

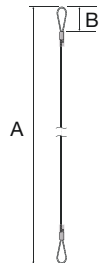

Part No.: S014001153401



Cable
SWL: 80 kg (176 lbs)

A = 2000 mm (78.7")
B = 70 mm (2.7")

Wire rope \varnothing = 3 mm

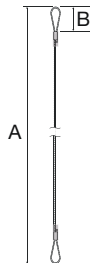

Part No.: S014002153501



Cable & 2 Carabiners
SWL: 80 kg (176 lbs)

A = 1200 mm (47.2")
B = 70 mm (2.7")

Wire rope \varnothing = 3 mm
Carabiner \varnothing = 7 mm

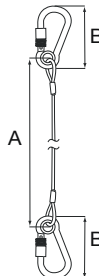

Part No.: S014002153601



Cable & 2 Carabiners
SWL: 80 kg (176 lbs)

A = 2000 mm (78.7")
B = 70 mm (2.7")

Wire rope \varnothing = 3 mm
Carabiner \varnothing = 7 mm

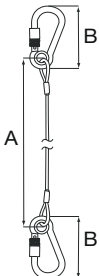

Part No.: S014002154001



Padlock
SWL: 80 kg (176 lbs)

A = 1000 mm (39.4")
B = 70 mm (2.7")
C = 53 mm (2.0")
D = 40 mm (1.6")
E = 32 mm (1.2")

Wire rope \varnothing = 3 mm
Padlock Shackle \varnothing = 7 mm

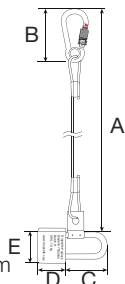

Protecting Your People

Asia Pacific

☎ +852 3664 8350 Hong Kong (Head Office)
☎ +800 492 2411 Singapore
✉ info@dropsafe.com

Australia

☎ 1 800 821 649
✉ australia@dropsafe.com

USA & Canada

☎ 1 866 299 2294
✉ usa@dropsafe.com
✉ canada@dropsafe.com

Europe

☎ +0 800 015 9709
✉ europe@dropsafe.com

Middle East & Africa

☎ +971 4 328 4855
✉ middleeast@dropsafe.com

Brazil

✉ brazil@dropsafe.com

Dropsafe is a proud member of:



Dropsafe[®]
Drops Prevention Technology